



Modern partitioning systems



MB-EXPO MB-EXPO MOBILE





PARTITION WALLING
SYSTEMS
MB-EXPO
MB-EXPO MOBILE

MB-EXPO MB-EXPO MOBILE

PARTITIONING SYSTEM

Tempered glass panes 8, 10, and 12 mm.

Two groups of profiles of different heights:
low - 36 mm, and high - 100 mm.





MB-EXPO system is an elegant, glass partition walling system designed for various types of internal partition walls with all-glass doors, whose function is to separate and to soundproof the selected areas, without visually limiting the space as it is the case with non-transparent walls.

MB-EXPO MOBILE is an internal walling system that enables fabrication of high-quality segment doors such as accordion and folding doors. The possibility of using **MB-EXPO MOBILE** in high ceilings areas (about 4 m high) and of having a wide, openable door, makes it a solution oriented mainly towards shops, shopping malls, exhibition centres and office buildings.



MB-EXPO & **MB-EXPO MOBILE** profiles are fitted to enable installation of the hardware (locks, hinges, suspension brackets, parked systems) manufactured by Aluprof and Geze. Panes are structural component of both systems and the glazing gaskets remain invisible, whichever the side. Both systems are offered in a variety of colours, and allow easy fabrication & installation.

MB-EXPO SELECTED CONFIGURATIONS

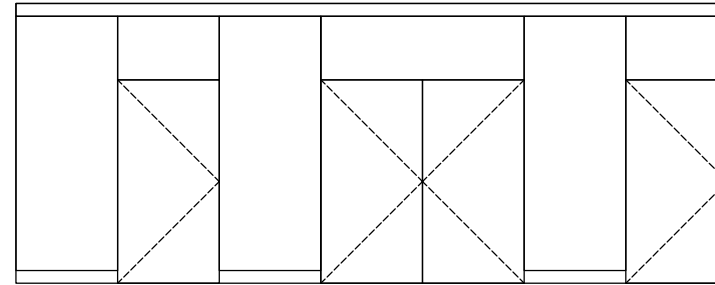
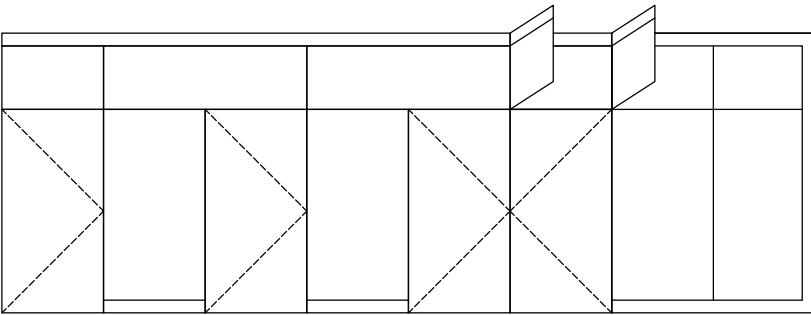
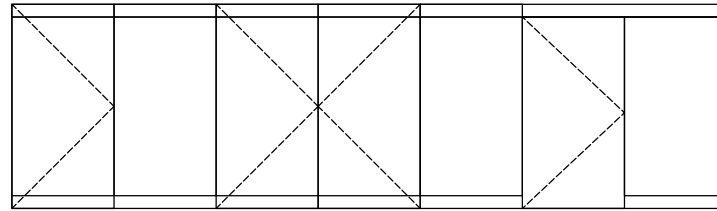
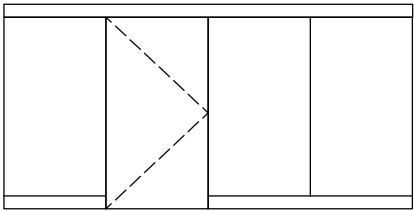

MB-EXPO MOBILE SELECTED CONFIGURATIONS

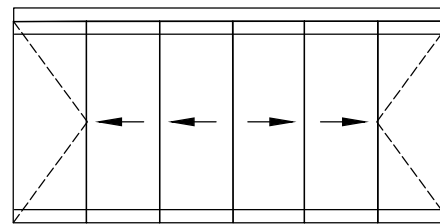
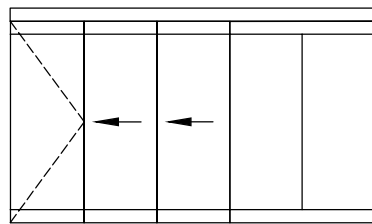
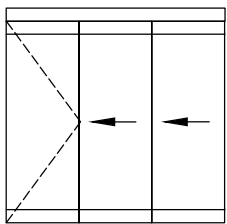

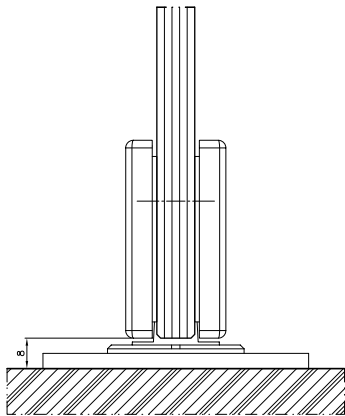

All-glass door leaf – lower view

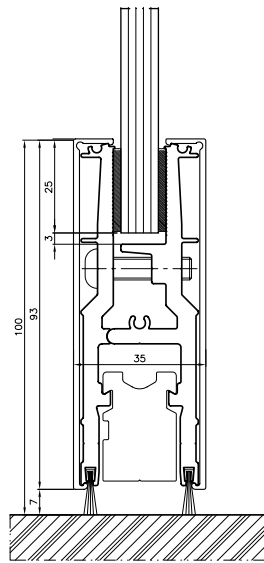

Mobile and door leaf – lower cross section

FEATURES AND BENEFITS

- invisible glazing gaskets
- light and elegant structure
- glazing 8, 10 and 12 mm
- fixed profile depth regardless of the glass pane thickness
- structures up to 4 m high
- adapted to use numerous companies' hardware products: Aluprof, Geze



MB-80 OFFICE





PARTITION WALLING
SYSTEMS
MB-80 OFFICE

MB-80 OFFICE

PARTITION WALLING SYSTEMS

Excellent sound insulation in office spaces – noise reduction of 50 dB, depending on the type of infill.

Different types of infill: glass panes, furniture boards, gypsum plasterboards.

Integrated partitions with electrical fittings.





This internal partition double-glass walling system is designed to fabricate internal partitions in offices and other public facilities.

The system enables the use of different types of infills, transparent or obscure, with internal louvers and electrical components and office equipment. These walls are especially suitable in buildings where a high sound insulation is required.



The basic feature of this construction is its versatility in arranging office space, combined with the simplicity of execution of all the works on site.

MB-80 OFFICE SELECTED CONFIGURATIONS

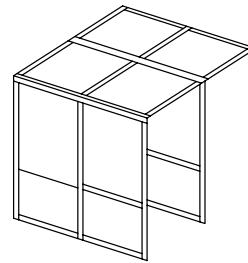
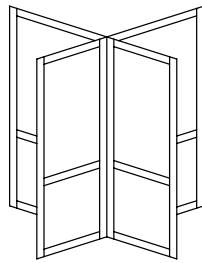
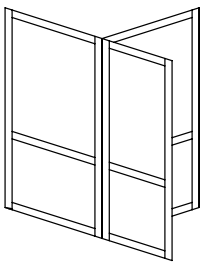
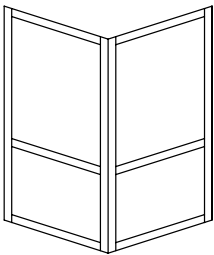
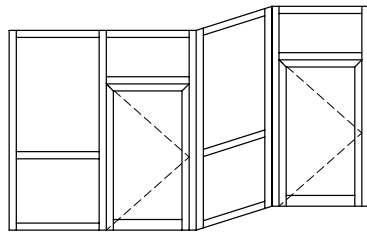
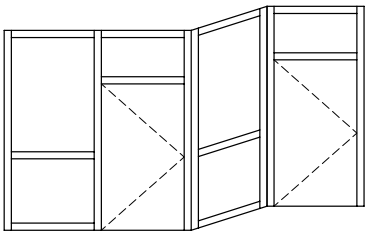
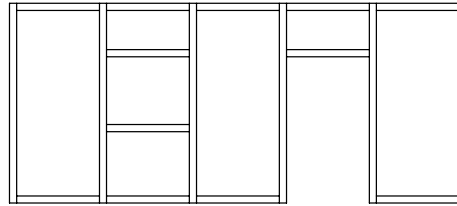
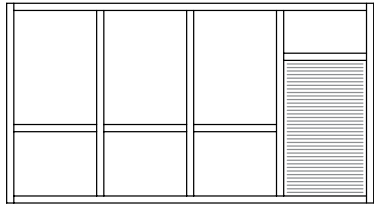
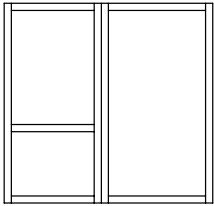

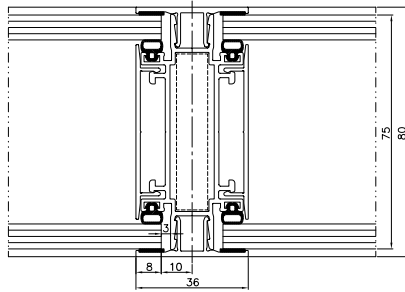

80 mm wall - vertical view

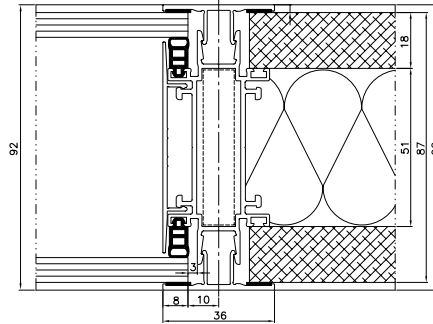

92 mm wall - vertical view

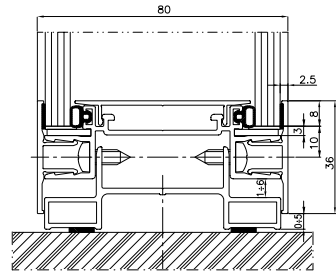

Lower crossbar - view

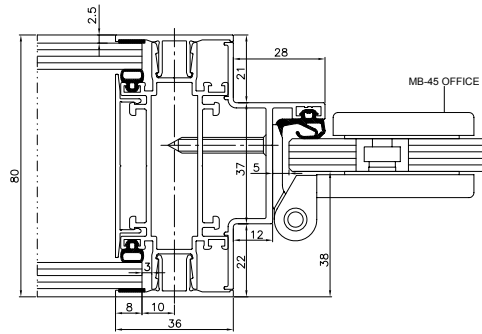

Door - horizontal view

FEATURES AND BENEFITS

- different types of infill: panes 4-14 mm thick, furniture boards 16-18 mm thick, gypsum plasterboards
- depth & construction of the basic profiles enables installation of intra-pane louvers
- can be combined with a standard, 75 mm-thick gypsum plasterboards
- excellent sound insulation in office spaces – noise reduction of 50 dB depending on the type of infill used
- possibility to fabricate 80 mm & 92 mm walls
- custom division of space, angle of refraction within the range 90°÷180°
- simple fabrication & installation, direct on-site pre-fabrication in option
- cables inside the wall, installation of standard power sockets
- can be combined with MB-45 wall or MB-45 (centrally or flushed with the plane of the wall) and with MB-45S door (flushed with the plane of the wall and with non-protruding hinges), and MB-45 OFFICE (with centrally-installed leaf, flushed with the plane of the wall, plus non-protruding hinges)
- max. development height: 5.5 m



MB-45 MB-45 OFFICE





PARTITION WALLING
SYSTEMS
MB-45
MB-45 OFFICE

MB-45 MB-45 OFFICE

PARTITION WALLING SYSTEMS

Various types of infills and glass panes can be used: both single and insulating, with thicknesses ranging from 2-25 mm. The system comes equipped with dedicated 8, 10 and 12 mm large-size tempered glass.

All-glass door leaves for hinged and swinging-type doors.

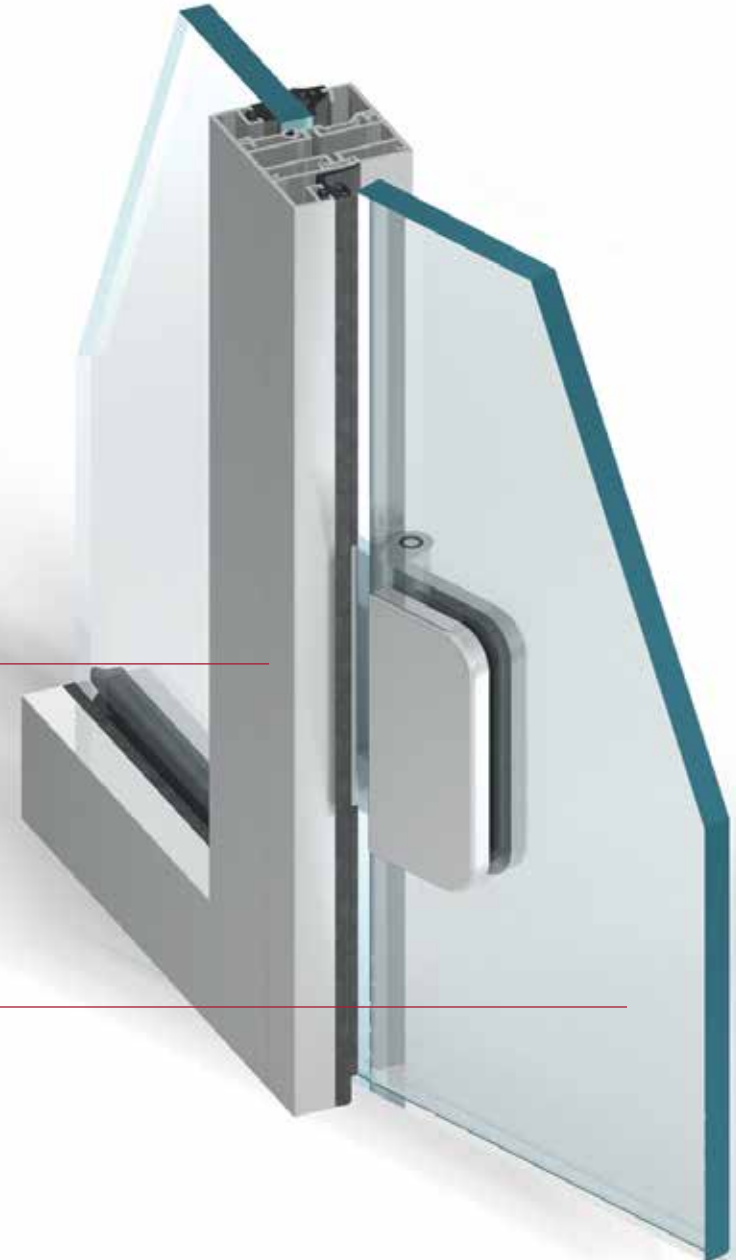



Due to its versatility and wide application possibilities, the **MB-45** & **MB-45 OFFICE** systems are dedicated to the fabrication of lightweight, yet solid partition walls in conference rooms and office spaces with “clearly marked” door.

The **MB-45 OFFICE** fixed and door-equipped partitioning system is designed to fabricate internal partition walls whose distinguishing feature is their tempered glass pane used as a structural component. The elements of this system enable fabrication of fixed partition walls and all-glass door leaves for hinged and swinging-type doors.



MB-45 is used to fabricate various types of partition walls, windows, doors, including manual & automatic sliding doors, swing doors, vestibules, and other spatial structures. **MB-45** can be used for special scenarios such as fabrication of smoke-resistant partition walls & doors **MB-45D** (classes: S_m , S_a).

MB-45 / MB-45 OFFICE SELECTED CONFIGURATIONS

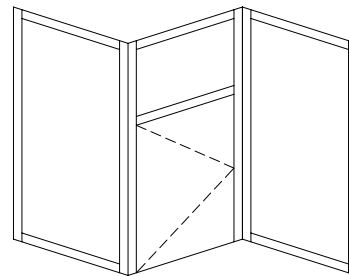
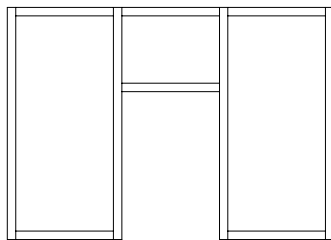
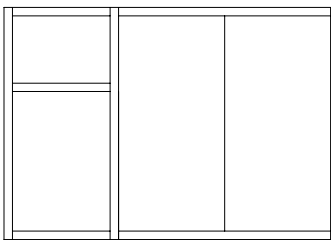
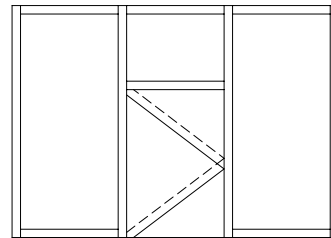
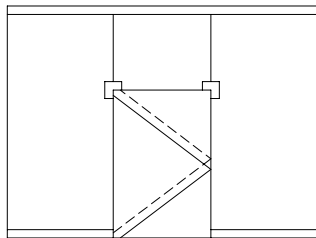
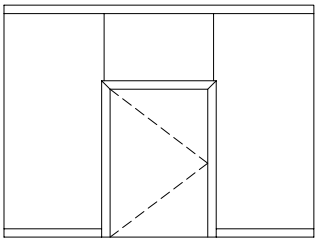
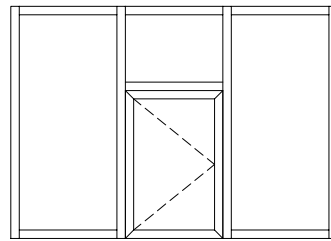
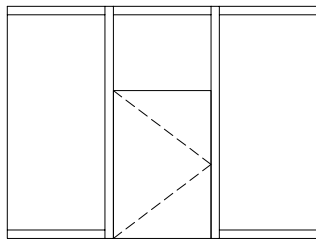
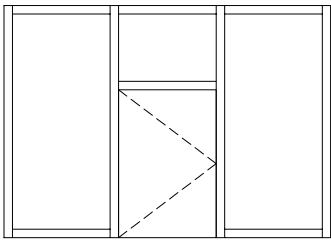
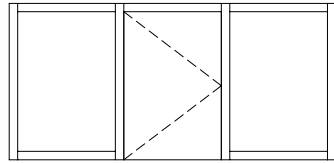
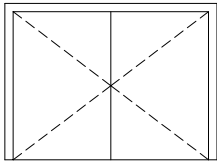
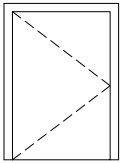

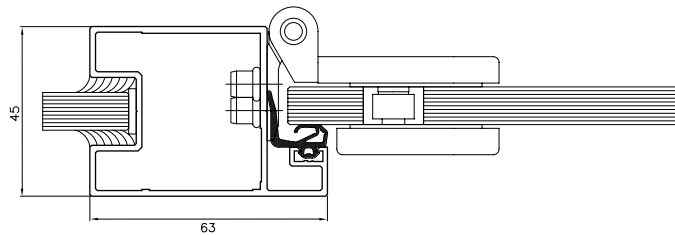

Door stud and upper crossbar - view

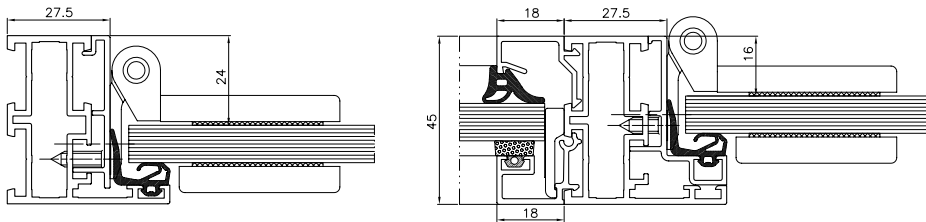

Door - side view

Door stud - section view

FEATURES AND BENEFITS

- light and durable structure
- design depth 45 mm
- infill ranging from 2-25 mm (dedicated, 8, 10 and 12 mm tempered glass panes)
- various types of partition walls, windows, doors, including manual & automatic sliding doors, swing doors, vestibules, etc.
- smoke-resistant doors MB-45D (in S_m and S_a classes)
- continuously mounted glazing gaskets, no more cutting at the corners
- possibility of changing interior design
- adapted to use numerous companies' hardware products: Aluprof WSS



MB-78EI





SYSTEM
SILICONE JOINED FIRE-
RATED GLAZED WALLS,
CLASSES **EI30** & **EI60**

MAKE THE SPACE LOOK OPTICALLY BIGGER

MB-78EI

PARTITION WALLING SYSTEMS

4 mm-thick joint.
Infill made of fire stop intumescent material
and non-flammable silicone.

Fire resistance classes
EI30 & EI60.

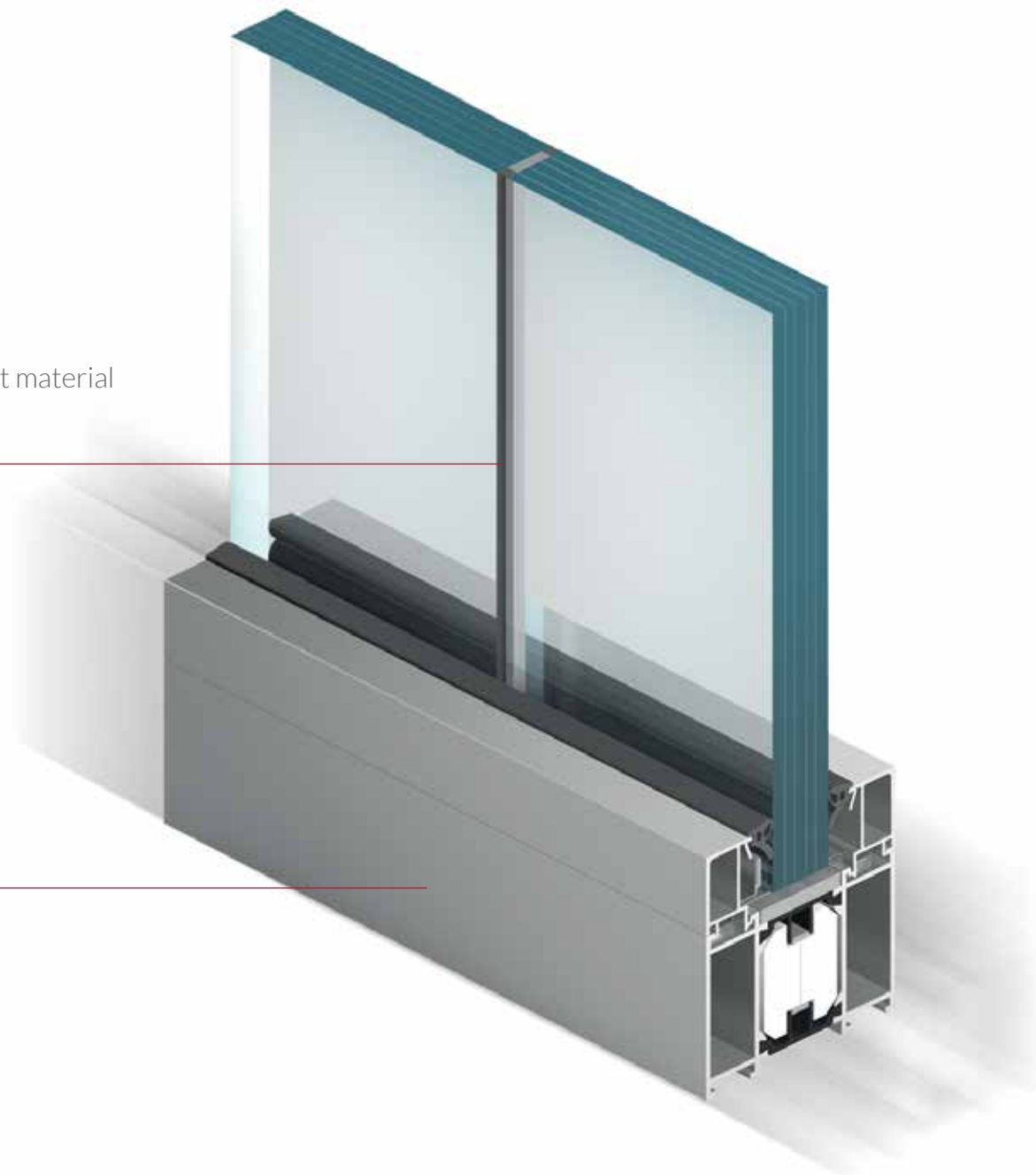

Aluprof offers **MB-78EI** system-based transparent fire-rated wall solution – **“Silicone joined fire-rated glazed walls”**.

It enables fabrication of internal partitions walls without the visible vertical wall profiles that separate the individual modules of the wall, while preserving its full fire resistance. The joint between the glass panes is only 4 mm, and is filled with firestop, intumescent material and with non-inflammable silicone. The silicone is available in three colours (black, grey or white).

Partition walls can thus have a height of more than 3.6 m with modules' width up to 1.8 m. Fire tests performed by the Poland's Building Research Institute (ITB) on these partition walls included the so-called “free-edge model”, so there is no limit on the maximum length of this type of walls.

MB-78EI Silicone joined glazed wall system brings you virtually unlimited design and construction possibilities, offering very large internal partition walling products. Thanks to the transparent modules, all the constructions fabricated using this system make your interiors optically bigger. The system also provides security by allowing the arrangement of the building's fire zones and this ensuring appropriate conditions for the evacuation of building occupants.

MB-78EI

PARTITION WALLING SYSTEMS

Transparent modules
up to 3.6 m high.

Fire resistance classes
EI30 & EI60.

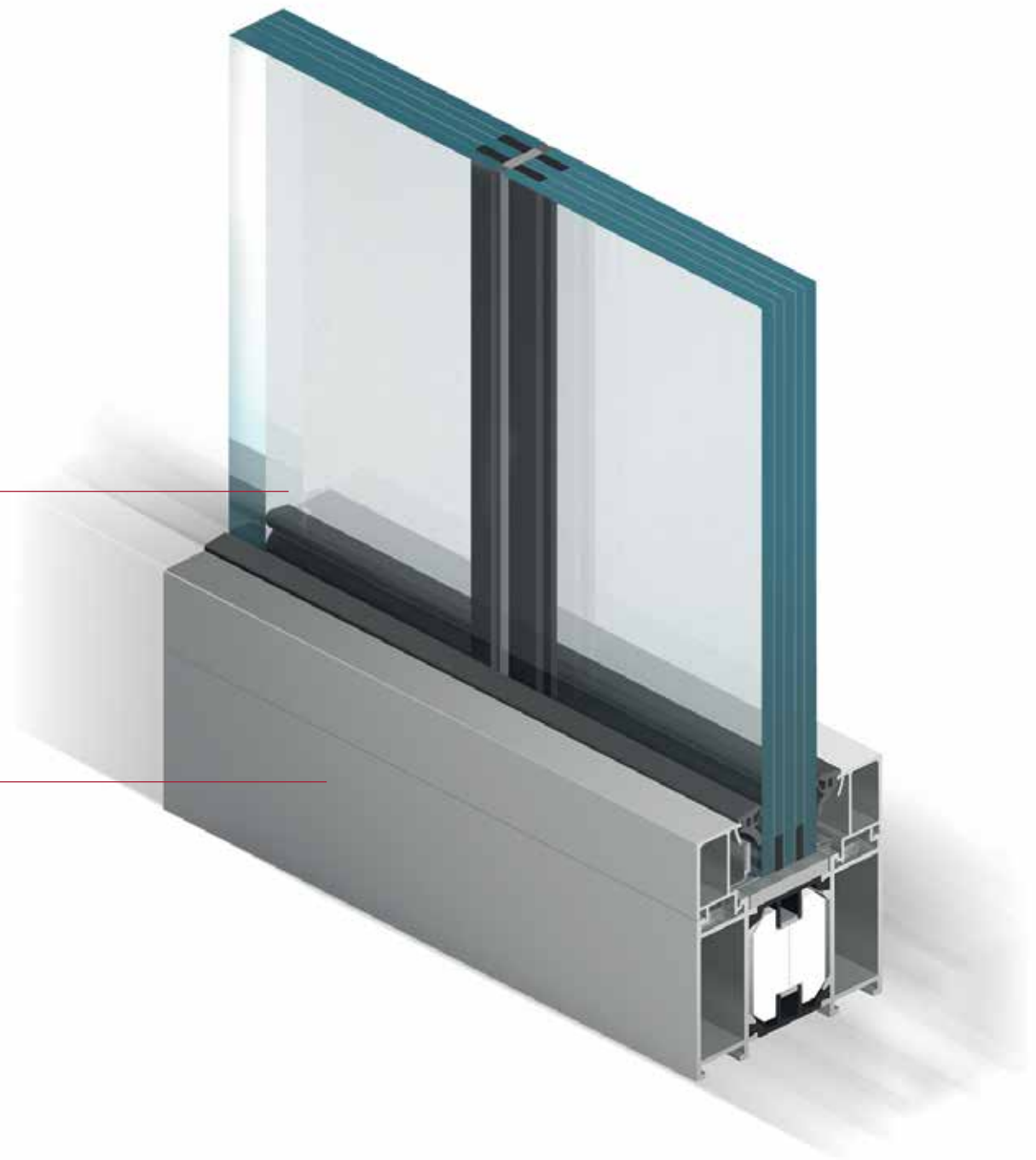

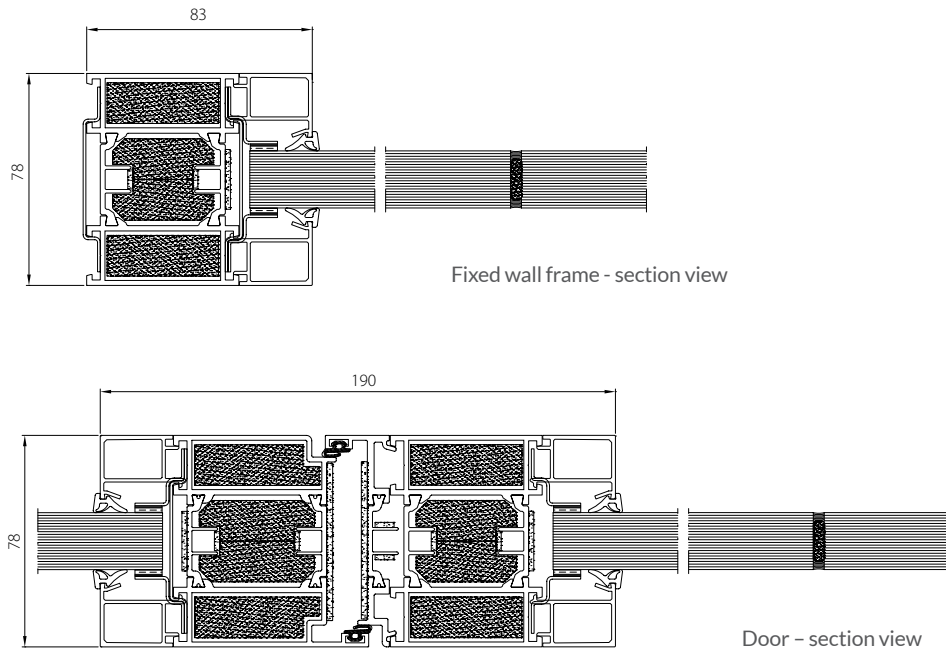

FEATURES AND BENEFITS

- Aluprof's solution has been designed and then tested at the ITB in two fire-rating classes: EI30 & EI60
- joint width between the modules is only 4 mm
- max. width of glass modules: 1.5 m (H max 3.6 m) and 1.8 m (H max 3.0 mm)
- unlimited width of a single wall



MB-78EI



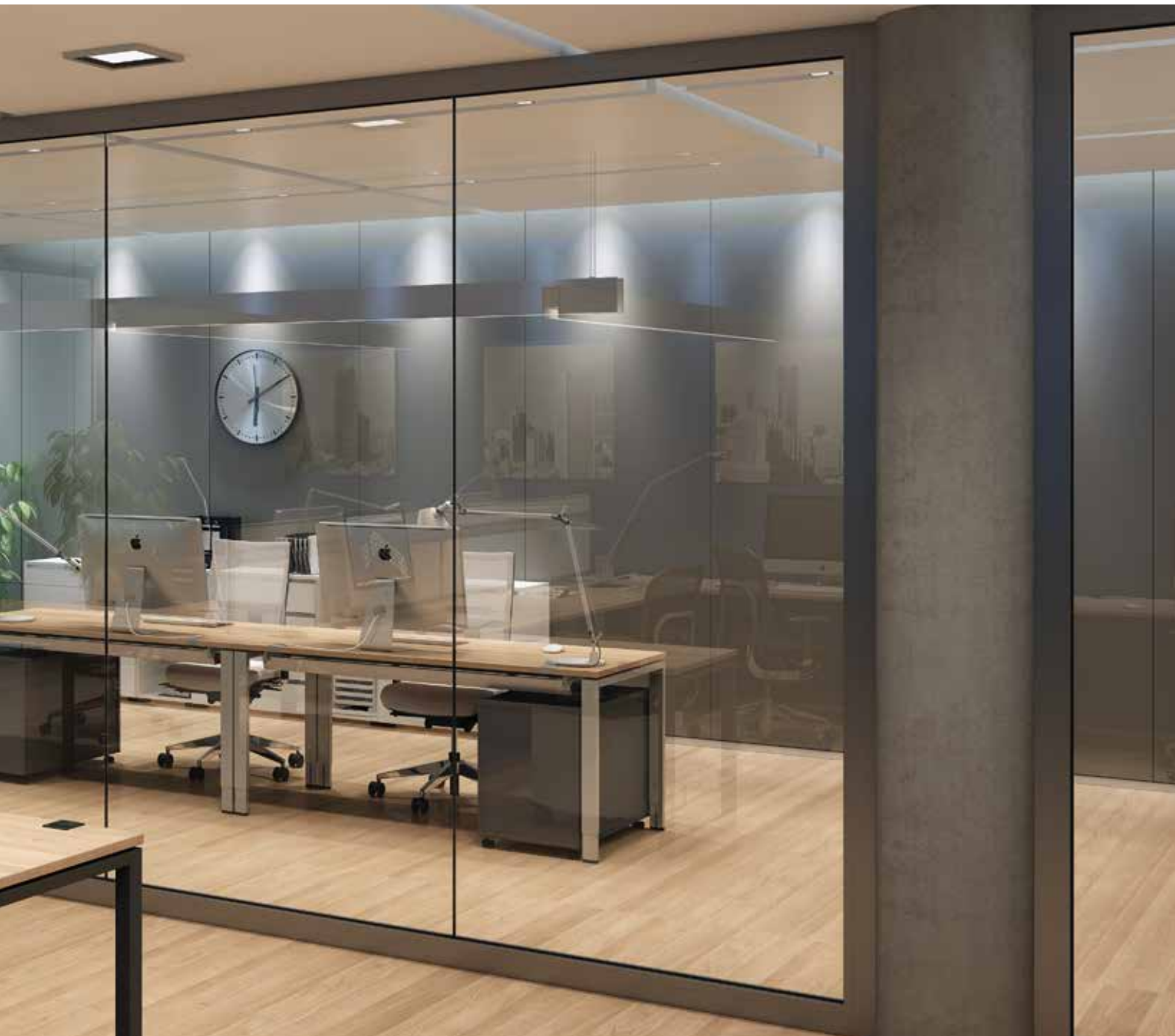

SYSTEM
SILICONE JOINED FIRE-
RATED GLAZED WALLS,
CLASSES **EI30** & **EI60**

MB-78EI

PARTITION WALLING SYSTEMS

The office is optically bigger thanks to the concealed wall mounting - modules of a width up to 1.8 m.

Available for fire resistance classes
EI30 & EI60.



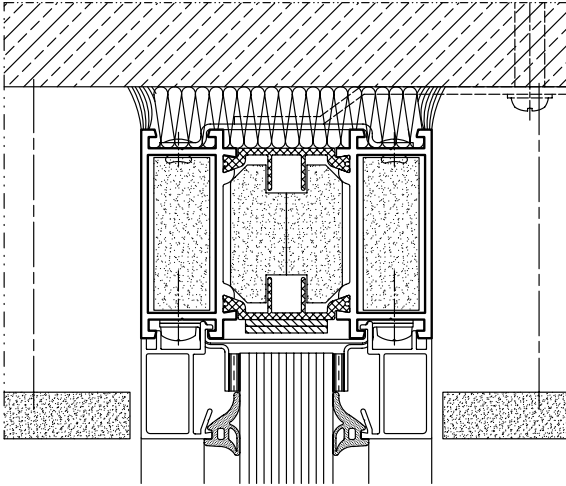

Silicone joined glazed wall – top

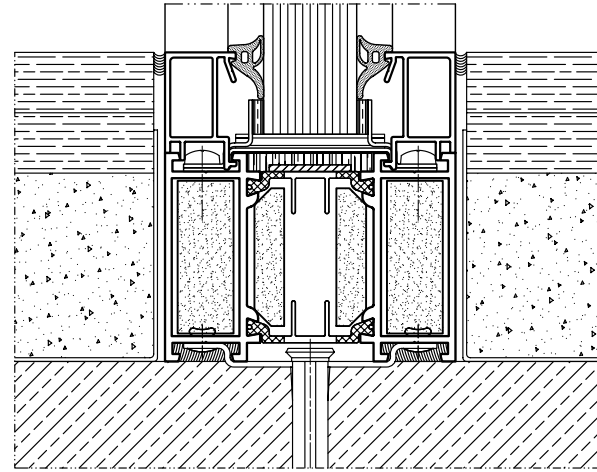

Silicone joined glazed wall – bottom

FEATURES AND BENEFITS

- available in two fire protection classes: E130 & E160
- joint width between the modules is only 4 mm
- max. width of glass modules: 1.5 m (H max 3.6 m) and 1.8 m (H max 3.0 m)
- unlimited width of a single wall



MB-78EI





SYSTEM
SILICONE JOINED FIRE-
RATED GLAZED WALLS,
CLASSES **EI30** & **EI60**



ALUPROF S.A.
ul. Warszawska 153, 43-300 Bielsko-Biała

tel. +48 33 81 95 300
fax. +48 33 82 20 512

 **ALUPROF**
www.aluprof.eu